

# AQ7275 OTDR

*Optical Time Domain Reflectometer*



- **Wide range of models available**
- **Supporting FTTH to core networks**
- **Short dead zone (0.8 m)**
- **High dynamic range (45 dB)**

Dead zone

**0.8m**

Dynamic range

**45dB**

For more information, go to  
[tmi.yokogawa.com](http://tmi.yokogawa.com)

Test & Measurement Instruments



# Superior cost performance, easy to operate. Makes your work more efficient. —

Meets a broad range of measurement needs from FTTH to metro, core networks.

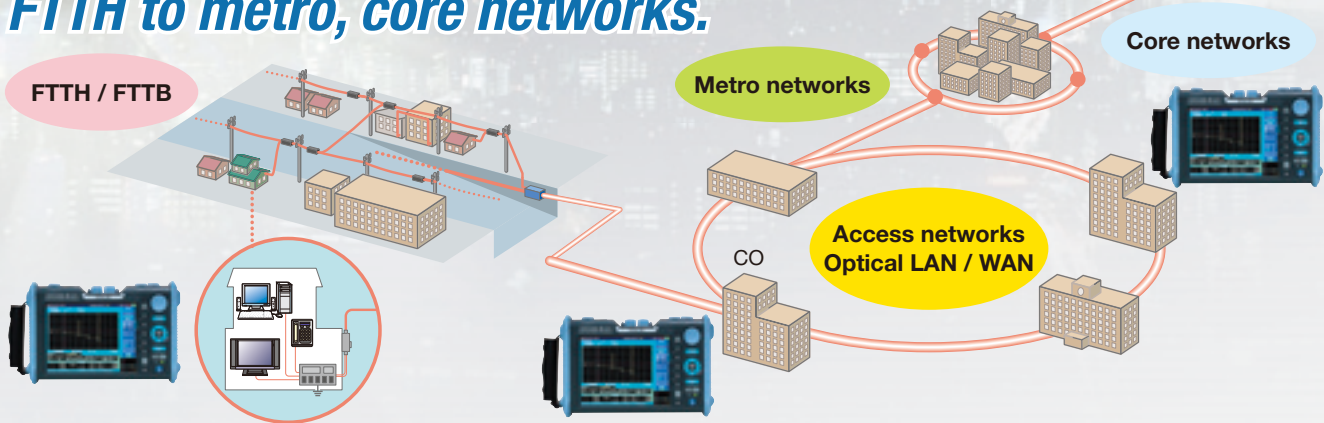

## Event Dead Zone 0.8 m

The AQ7275's short event dead zone enables detection of closely spaced events in cables installed in offices and customer premises.

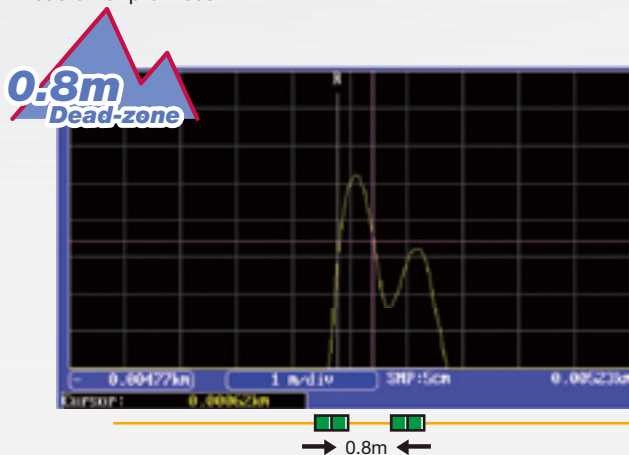

## High Dynamic Range up to 45 dB

The high dynamic range model (735034) can achieve the dynamic range of 45 dB. This high dynamic range is effective in measuring a transmission line consisting of long fiber cables and a splitter with a large loss.

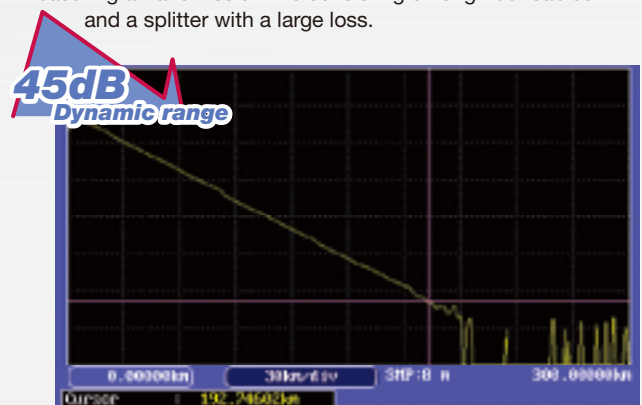

## Quick Startup within 10 Seconds

Now measurements can be started quickly upon arrival at the site. 10 seconds to power-up from completely OFF to fully ON! With such a fast power-up time, battery life can be extended by turning the power off while not in use at the job site without any concern about the power-up time when the next job is ready. It's ready when you're ready!

## Wide Range of Models Available

| Applicable fiber | No. of Wavelength | Wavelength                | Dynamic range  | Model  | Descriptions   |
|------------------|-------------------|---------------------------|--|--------|--|
| SMF              | 1                 | 1650nm                    | 30dB   | 735031 | <b>NEW</b> 1650nm model, supporting maintenance wavelength of 1650nm including 1310/1550nm cut filter.   |
|                  | 2                 | 1310/1550nm               | 34/32dB  | 735032 | Standard model for installation and maintenance of FTTH  |
|                  | 2                 | 1310/1550nm               | 40/38dB  | 735033 | Standard model for installation and maintenance of Metro and Access network  |
|                  | 2                 | 1310/1550nm               | 43/41dB<br>45/43dB(typ)                                  | 735034 | <b>NEW</b> High dynamic range model for installation and maintenance of Core and Metro network   |
|                  | 3                 | 1310/1490/1550nm          | 34/30/32dB   | 735035 | <b>NEW</b> 3-wavelength model for PON system, supporting 1490nm  |
|                  | 3                 | 1310/1550/1625nm          | 40/38/33dB   | 735036 | <b>NEW</b> Three-wavelength model, supporting a maintenance wavelength of 1625nm including 1310/1550nm cut filter  |
|                  | 3                 | 1310/1550/1650nm          | 40/38/30dB   | 735037 | Three-wavelength model, supporting a maintenance wavelength of 1650nm including 1310/1550nm cut filter.  |
|                  | 3                 | 1310/1550/1625nm          | 40/38/36dB   | 735038 | <b>NEW</b> Three-wavelength model, supporting a maintenance wavelength of 1625nm   |
| MMF SMF          | 4                 | 850/1300nm<br>1310/1550nm | 22.5/24dB (62.5GII)<br>21.5/23dB (50GI)<br>40/38dB (SMF) | 735041 | <b>NEW</b> Four-wavelength model for installation and maintenance of LAN and FTTH with support for both multimode and single mode fiber. Dynamic range is specified when measuring 50GI fiber. |

# AQ7275 OTDR

## Easy to Operate for Beginners and Experts

Setup mode can be selected according to the skill level of technicians.

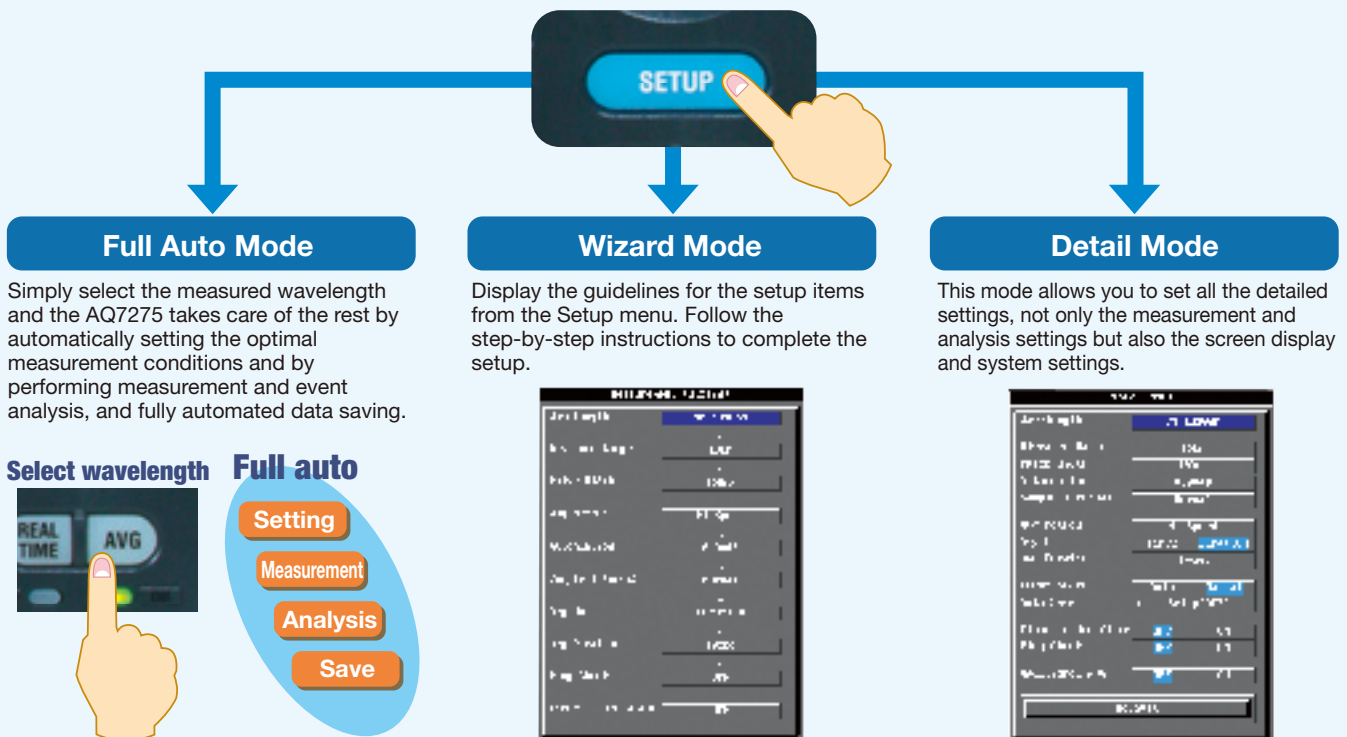

### Measurement with Auto Wavelength Switching – Multi Wavelength Measurement Mode

Prepare multiple wavelengths to measure, then press a button.

Multi Wavelength Measurement is a mode in which multiple specified wavelengths from the same optical port are measured automatically in order. You can also specify to perform analysis or file saving as needed for each measurement.

Wavelength switches automatically

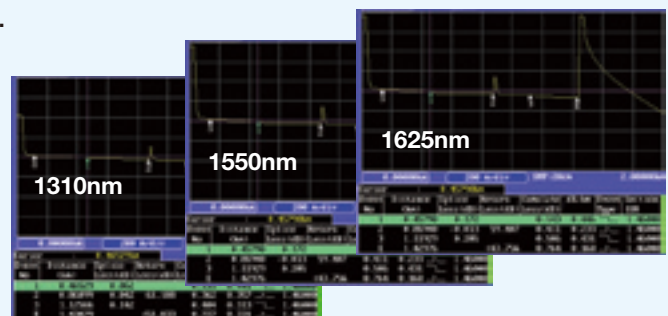
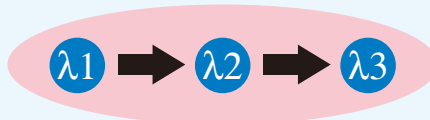

### Measurement with Comparison to Reference Waveform – Trace Fix Function

You can freeze the display of one trace and overlap it with real time or averaged waveforms for comparison. This is useful to create a template when installing multicore fiber, or for checking aged deterioration during maintenance on existing fiber networks. In addition to the last-measured waveform, a waveform can be loaded from a file to be used as the reference waveform.

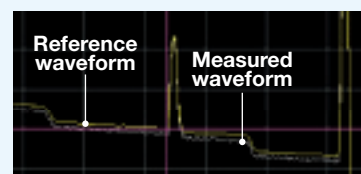

Trace Fix Function

### USB Function

The AQ7275 has two USB 1.1 compliant connector ports as standard (Type A and Type B).

Type A port is for USB memory and USB hard disk drive for storage.

Type B port is for connecting external PC. AQ7275 can be remotely controlled from external PC, and the internal memory of AQ7275 can be accessed from external PC directly.



Type A



Type B

# Increase Working Efficiency

## Multi Fiber Measurement Function

The Multi fiber measurement function automatically performs measurements and data-filing according to a pre-established file name table. At worksite, you can execute it by simply selecting a fiber number in the table.

The saved waveform can be easily shown in the preview window by selecting the core number in the table.

The OTDR Project File Editor included in AQ7932 Emulation Software greatly saves time to create file name table.



Multi fiber measurement function menu

- Making a table for fibers to be tested.
- The fiber to be skipped can be selected.
- Any of the fibers can be selected to execute the measurement.
- The check-mark appears for the fiber that the measurement is completed.
- The file name is created for the selected fiber automatically.
- With the preview window, waveform can easily be confirmed.

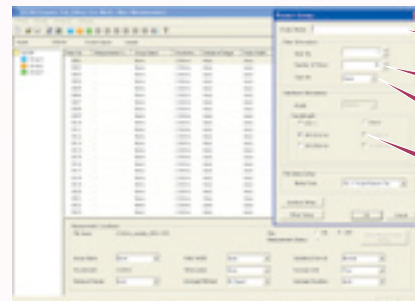

OTDR Project File Editor menu on PC

- Comment (Location...)
- Number of core
- Tape ID
- Measuring conditions
- [Project File]  
File name, Measuring conditions are stored as a table.

## Measured Data Analysis and Report Creation Tool –AQ7932 OTDR Emulation Software (Sold Separately)

AQ7932 is application software that performs analysis of trace data measured by AQ7270 and AQ7275 OTDR on a PC, and creates reports. The report creation wizard function makes this task simple. AQ7270 and AQ7275 OTDR data can be easily loaded onto a PC using USB memory or storage function.

### Trace Analysis

You can edit event search conditions, approximate curve line settings, and other analysis conditions, and repeat the analysis. Operation is also easy. Simply click the function icon.

### Variety of Analysis Functions

Display up to eight traces on screen, and perform a variety of analyses including multi-trace analysis and differential trace analysis for comparing recent waveforms with old ones, and use the 2 way trace analysis function for analyzing average values of data measured from both directions in the optical fiber.

### OTDR Project File Editor for Multi Fiber Measurement

By registering a comment, number of cores, Tape ID, wavelength, etc., the OTDR Project File Editor creates "File name table" called "Project". It can be used in combination with Multi fiber measurement function available on AQ7270 and AQ7275.

### Creating Reports

You can compile trace and measured values from trace files and creates a report. Reports can also be created in Excel and CSV formats. Reports can be created easily by just following the step-by-step instructions in the report wizard.

#### Functionality

File format: .SOR (Bellcore), .SOR (Telcordia [AQ7275, AQ7270, AQ7260]), .TRD (AQ7260), .TRB (AQ7250), .BMP (BMP), .CSV (Data CSV), .CSV (Event List CSV)  
Report output format: Print output, CSV file, XLS file

#### Recommended Operating Environment (Software and Hardware)

- OS: Microsoft Windows 2000, Microsoft Windows XP, Microsoft Windows Vista \*
- Excel: Microsoft Excel 2000 or later (when the XLS file output function is used)
- PC: Clock speed: Environment in which the OS operates smoothly.
- HD capacity: 20 MB or more space required at the time of installation
- Memory capacity: 128 MB or more (256 MB or more recommended)
- Display: Resolution of 1024x768 pixels or better
- Disc drive: CD-ROM drive

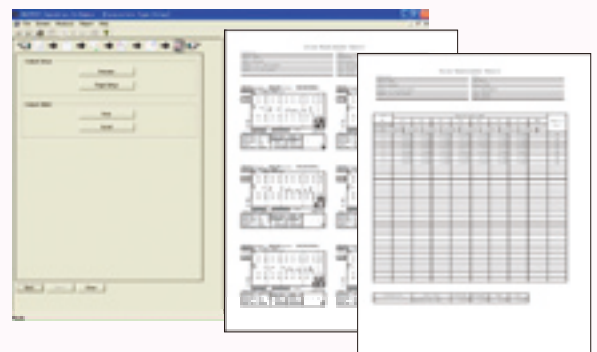
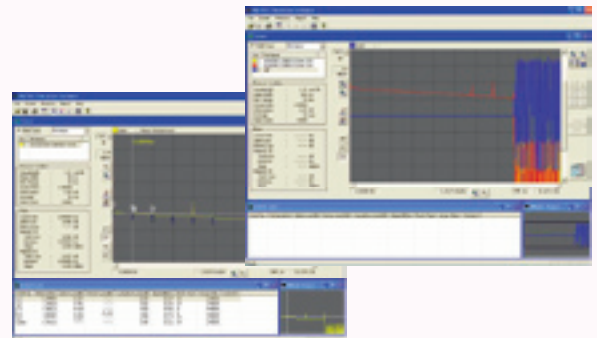

Microsoft Windows 2000, Windows XP, and Windows Vista are registered trademarks or trademarks of Microsoft Corporation in the United States and other countries. The TM and © symbols are not used to indicate registered trademarks and trademarks in this document.  
(\* ) Microsoft Windows Vista is to be supported in Ver3.03 and later.

# Support Remote Monitoring NEW

## Remote Control Software

OTDR can be remotely controlled from personal computer (PC) through Ethernet or the USB interface. The front panel image of connected OTDR is displayed on the screen of PC with remote control software, and OTDR can be controlled from PC by using the mouse by a similar sense of the operation of OTDR.

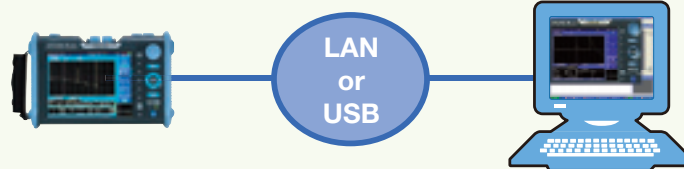

## Monitoring Software for Intermittent Disconnection

This PC software is for detecting and monitoring intermittent disconnection of optical fiber which is connected to OTDR. OTDR is controlled by personal computer (PC) through Ethernet or USB interface. Intermittent disconnection (200ms or more) can be detected and measured trace by OTDR can be stored in PC. By using this software point of intermittent disconnection can be located.

# More Value Added to OTDR – Wider Range of Optional Functions

## Stabilized Light Source

This light source option can be used for measuring losses. It can also be used for optical fiber identification, because it is capable of outputting not only continuous wave (CW) light but also a 270-Hz modulated light.

\* The stabilized light source option cannot be used for the 735041 (MMF).



Fiber Identification

Loss Measurement

## Visible Light Source

This option can be used for identifying the multicore fiber cable and visually checking for a failure. The adopting the connector connection method enables the visible light to reach greater distances with less light leakage.

\* The visible light source option cannot be applied for the 735036, 735037 and 735041.

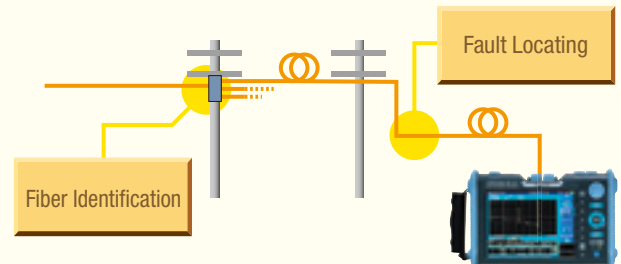

## Built-in Dummy Fiber

You can use the dummy fiber to effectively detect abnormal near-end connection loss.

\* The dummy fiber option cannot be used for the 735041.  
\* The built-in dummy fiber is not attachable and removable.

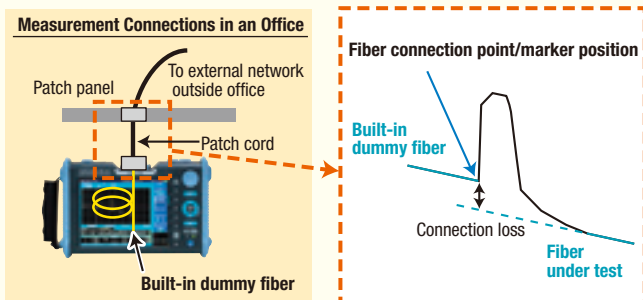

## Optical Power Monitor

This is useful for simply checking optical power when performing link loss testing or troubleshooting.

\* The optical power monitor option cannot be used for the 735031 and 735041 (MMF).



Fiber Identification

Power Check

## Angled-PC Connector

You can connect an optical fiber with an angled-PC connector directly to the OTDR. The angled PC is often used for CATV networks to reduce the influence of reflection.

## External Large Capacity Battery

The operation time will triple that of a standard built-in battery.

## Printer/LAN

Measured results can be printed on site. It makes it easy to attach waveforms and results to your report. Remote control and FTP (file transfer) via LAN is also possible.

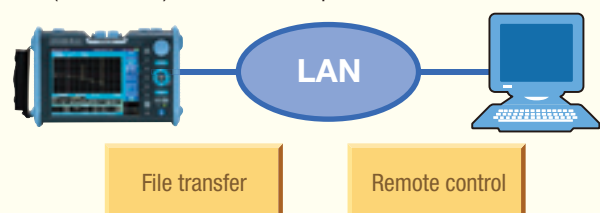

## Common Specifications

### Horizontal Axis Parameters

|                               |   |
|-------------------------------|---|
| Sampling resolution           | 5 cm, 10 cm, 20 cm, 50 cm, 1 m, 2 m, 4 m, 8 m, 16 m, 32 m   |
| Readout resolution            | 1 cm (Min.)   |
| Number of sampled data        | Up to 50,000 points   |
| Group refractive index        | 1.30000 to 1.79999 (in 0.00001 steps)   |
| Unit of distance              | km, kf or miles   |
| Distance measurement accuracy | Sum of the following 3 errors<br>Offset error: ±1 m<br>Scale error: Measurement distance × 2 × 10 <sup>-5</sup><br>Sampling error: ±1 sampling resolution |

### Vertical Axis Parameters

|                            |  |
|----------------------------|--|
| Vertical axis scale        | 0.2 dB/div, 0.5 dB/div, 1 dB/div, 2 dB/div, 5 dB/div, 7.5 dB/div |
| Readout resolution         | 0.001 dB (Min.)  |
| Loss measurement accuracy* | ±0.05 dB/dB  |

\*When the measuring loss is 1 dB or less, the accuracy is within ±0.05 dB.

### OTDR Measurement Function

|                         |  |
|-------------------------|--|
| Distance measurement    | Displays up to eight digits of the relative one-way direction between two arbitrary points on the trace.   |
| Loss measurement        | Displays one-way loss in steps of 0.001 dB to a maximum of 5 digits. Displays the one-way loss, loss per unit length, and splice loss between any arbitrary points on the trace. |
| Return loss measurement | Measures return loss and total return loss of a fiber cable or between two arbitrary points on the trace.  |
| Scheduling function     | Performs measurements and saves results onto a USB storage in a user defined time frame and interval automatically.  |

### OTDR Analysis Functions

|                    |   |
|--------------------|---|
| Analysis functions | Multi trace analysis, 2 way trace analysis, differential trace analysis, section analysis |
|--------------------|---|

### Internal Memory

|                 |   |
|-----------------|---|
| Memory capacity | 1000 waveforms or more<br>Can store measured waveforms and measurement conditions |
|-----------------|---|

### Display

|                                   |  |
|-----------------------------------|--|
| Display                           | 8.4-inch color TFT LCD, semi-transparent |
| Total number of displayed pixels* | 640 (horizontal) × 480 (vertical) pixels |

\*The LCD may contain some pixels that are always ON or OFF (0.002% or fewer of all displayed pixels including RGB), but this is not indicative of a general malfunction.

### External Interface

|     |   |
|-----|---|
| USB | USB1.1 Type A and Type B, one each<br>Type A: For external memory<br>Type B: For connecting to an external PC for remote control or access to the OTDR's internal memory. |
|-----|---|

### File Formats

|              |   |
|--------------|---|
| File formats | Read: SOR, TRD, TRB, SET (AQ7270/75)<br>Write: SOR (Telcordia), SET, CSV, BMP, JPG, PNG |
|--------------|---|

### General Specifications

|                        |  |
|------------------------|--|
| Operating environment  | Temperature 0 to 45°C (0 to 35°C when charging the battery)<br>Humidity 85% RH or less (no condensation) |
| Storage temperature    | -20 to 60°C  |
| Battery                | Operation time 6 hours (18 hours with external large capacity battery)*1<br>Recharge time 5 hours *2     |
| Rated power voltage    | 100 to 240 VAC   |
| Rated supply frequency | 50 to 60 Hz  |
| Power consumption      | Max 70 W (when charging battery and printing with optional printer)                                      |
| Dimensions             | (W) 287 × (H) 197 × (D) 85 mm (excluding projections or options)   |
| Weight                 | Approx. 2.8 kg (excluding options)   |
| Laser safety standards | Class 1 M (IEC 60825-1:1993 + A2:2001)*3<br>21CFR1040.10*4   |
| Safety standard        | EN61010-1  |
| Emission               | EN61326-1 Class A<br>EN55011 Class A Group 1   |
| Immunity               | EN61326-1 Table 2  |

\*1 Measurement for 30 seconds in every 10 minutes without any options and in power save mode (Auto Power OFF 1 minute)

\*2: Ambient temperature of 23°C, power OFF

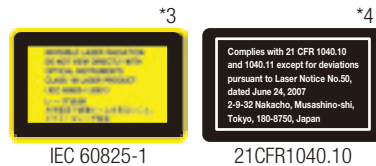

### External Dimensions

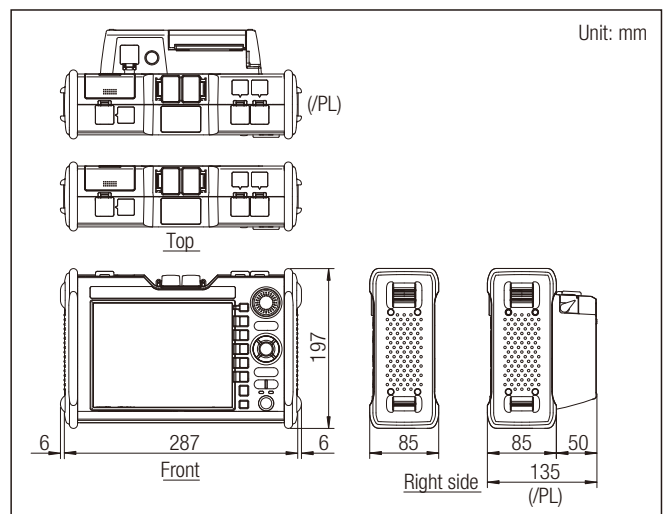

## Specifications by Model

| Model                     | 735031 *11  | 735032          | 735033          | 735034                      | 735035              |
|---------------------------|---|-----------------|-----------------|-----------------------------|---------------------|
| Wavelength *13            | 1650±5nm*1, ±10nm*2   | 1310/1550±25 nm | 1310/1550±25 nm | 1310/1550±25nm              | 1310/1490/1550±25nm |
| Applicable fiber          | SM (ITU-T G.652)  |                 |                 |                             |                     |
| Distance range            | 500m, 1km, 2km, 5km, 10km, 20km, 50km, 100km, 200km, 300km, 400km     |                 |                 |                             |                     |
| Pulse width *3            | 3ns, 10ns, 20ns, 50ns, 100ns, 200ns, 500ns, 1µs, 2µs, 5µs, 10µs, 20µs |                 |                 |                             |                     |
| Dynamic range             | 30 dB *4  | 34/32 dB *4     | 40/38 dB *4     | 43/41 dB *4, 45/43 dB (typ) | 34/30/32 dB *4      |
| Event dead zone *10       | 0.8m *5   | 0.8m *5         | 0.8m *5         | 0.8m *5                     | 0.8m *5             |
| Attenuation dead zone *10 | 12 m (typ) *6   | 7/8 m (typ) *6  | 7/8 m (typ) *6  | 7/8 m (typ) *6              | 7/8/8 m (typ) *6    |

| Model                     | 735036 *11  | 735037 *11                             | 735038               | 735041         |   |
|---------------------------|---|--|----------------------|----------------|---|
| Wavelength *13            | 1310/1550±25 nm<br>1625±25 nm   | 1310/1550±25 nm<br>1650±5nm*1, ±10nm*2 | 1310/1550/1625±25 nm | 1310/1550±25nm | 850/1300±30nm   |
| Applicable fiber          | SM (ITU-T G.652)  |  |                      |                | GI (62.5/125µm, 50/125µm)                                       |
| Distance range            | 500m, 1km, 2km, 5km, 10km, 20km, 50km, 100km, 200km, 300km, 400km     |  |                      |                | 500m, 1km, 2km, 5km,<br>10km, 20km, 50km, 100km                 |
| Pulse width *3            | 3ns, 10ns, 20ns, 50ns, 100ns, 200ns, 500ns, 1µs, 2µs, 5µs, 10µs, 20µs |  |                      |                | 3ns, 10ns, 20ns, 50ns, 100ns,<br>200ns, 500ns, 1µs, 2µs, 5µs *8 |
| Dynamic range             | 40/38/33dB *4   | 40/38/30dB *4                          | 40/38/36dB *4        | 40/38dB *4     | 21.5/23dB(50/125µm)<br>22.5/24dB(62.5/125µm) *8                 |
| Event dead zone *10       | 0.8m *5   | 0.8m *5                                | 0.8m *5              | 0.8m *5        | 1m *9   |
| Attenuation dead zone *10 | 7/8/12 m (typ) *6   | 7/8/12 m (typ) *6                      | 7/8/12 m (typ) *6    | 7/8 m (typ) *6 | 6/10 m (typ) *12  |

\*1 At a point -20 dB from the pulse light output peak value (measured 30 minutes or more after power-on at an ambient temperature of 23°C)

\*2 At a point -60 dB from the pulse light output peak value (measured 30 minutes or more after power-on at an ambient temperature of 23°C)

\*3 Pulse width setting range depends on the distance range

\*4 SNR:1, pulse width: 20 µs, distance range: 200 km, sampling resolution: 8 m, measurement time: 3 minutes. When built-in dummy fiber and angled-PC connector are used, each dynamic range decreases by 0.5 dB

\*5 Pulse width of 3 ns, return loss of 45 dB or more at a point 1.5 dB below the peak value (not saturated)

\*6 Pulse width of 10 ns and return loss of 45 dB or more at a point where the backscatter level is within ±0.5 dB of the normal value

\*7 Pulse width of 2 or 5 µs when the measured wavelength is 1300 nm

\*8 SNR = 1 at pulse width of 500 ns (850 nm) and 1 µs (1300 nm), sampling resolution of 8 m, and measurement time of 3 minutes

\*9 Pulse width of 3 ns and return loss of 40 dB or more at a point 1.5 dB below the peak value (not saturated)

\*10 At group reflective index 1.5

\*11 Pulse light output power at 1625 nm and 1650nm, 15dBm or less, built-in 1310/1550nm cut filter

\*12 Pulse width of 10ns and return loss of 40dB or more at a point where the backscatter level is within ±0.5dB of the normal value

\*13 Pulse width of 1 µs

Note: Specifications without any special remarks are assured at 23°C±2°C

## Factory Installed Optional Specifications

### Stabilized Light Source Function (/SLS option)

|                                      |   |
|--------------------------------------|---|
| Optical connector                    | Shared with the OTDR (at the same port) |
| Center wavelength                    | OTDR's center wavelengths               |
| Light output level                   | -5 dBm or more (at 23°C±2°C)            |
| Output level stability               | ±0.1 dB (±0.15 dB for 1650 nm)          |
| (Constant temperature for 5 minutes) |   |
| Modulation frequency                 | CW, 270 Hz                              |

\* Unavailable for the 735041 (MMF)

### Visible Light Source (/VLS option)

|                       |                                  |
|-----------------------|----------------------------------|
| Optical connector     | Port is not shared with the OTDR |
| Center wavelength     | 650 nm ± 20 nm                   |
| Light output level    | Peak value -3 dBm or more        |
| Modulation frequency  | 2 Hz                             |
| Laser safety standard | Class 3R                         |

\* Unavailable for the 735036, 735037 and 735041



### Power Monitor Function (/PM option)

|                        |   |
|------------------------|---|
| Optical connector      | Shared with the OTDR (at the same port)<br>(735036, 735037 : 1310/1550 nm port) |
| Measurement wavelength | 1310, 1490, 1550, 1625, 1650 nm   |
| Measurement range*1    | -50 to -5 dBm   |
| Measurement accuracy*2 | ± 0.5 dB  |

\*1 CW light, absolute maximum input level 0 dBm (1 mW)

\*2 CW light, wavelength 1310 nm, -10 dBm for input, 23°C±2°C

\* Unavailable for the 735031 and 735041 (MMF)

### PON measurement (/PN option)

|                   |  |
|-------------------|--|
| Applicable models | 735031, 735033, 735036, 735038                       |
| Dynamic range     | 25/25/23/19dB (typ)<br>(1310nm/1550nm/1625nm/1650nm) |

Applicable pulse width 50ns, 100ns, 200ns, 500ns, 1µs

\* Dynamic range is for the 100ns of pulse width.

\* At pulse widths not applicable to the PON option, the performance is equal to the standard model.

### High Dynamic range (/DR option)

|                  |                               |
|------------------|-------------------------------|
| Applicable model | 735032                        |
| Dynamic range    | 36dB (1310nm) / 34dB (1550nm) |

\* SNR:1, pulse width: 20 µs, distance range: 200 km, sampling resolution: 8 m, measurement time: 3 minutes. When built-in dummy fiber and angled-PC connector are used, each dynamic range decreases by 0.5 dB

### Built-in Printer/LAN Function (/PL option)

|                       |  |
|-----------------------|--|
| Printing method       | Thermal line-dot   |
| Dot density           | 576 dots/line  |
| Paper width           | 80 mm  |
| Operating environment | Temperature 0 to 40°C<br>Humidity 10 to 80% RH (no condensation) |
| Storage temperature   | -20 to 60°C  |
| LAN function          | 10BASE-T/100BASE-TX (RJ-45) x1                                   |

### Dummy Fiber (/DF option)

|                      |                  |
|----------------------|------------------|
| Optical fiber        | SM (ITU-T G.652) |
| Optical fiber length | Approx. 100 m    |

\* Dynamic range declines by 0.5 dB as a result of the addition of the fiber option.

\* Unavailable for the 735041

# Optical Time Domain Reflectometer AQ7275 OTDR

## Model and Suffix Code

### AQ7275 OTDR

| Model  | Option availability   |                         |                      |                 |                    |             |             | Remarks                                |
|--------|-----------------------|-------------------------|----------------------|-----------------|--------------------|-------------|-------------|--|
|        | Optical power monitor | Stabilized light source | Visible light source | PON measurement | High Dynamic range | Printer/LAN | Dummy fiber |  |
| 735031 | —                     | √                       | √                    | √               | —                  | √           | √           | 1-port, SM1650nm, filter               |
| 735032 | √                     | √                       | √                    | —               | √                  | √           | √           | 1-port, SM1310/1550 nm                 |
| 735033 | √                     | √                       | √                    | √               | —                  | √           | √           | 1-port, SM1310/1550 nm, High DR        |
| 735034 | √                     | √                       | √                    | —               | —                  | √           | √           | 1-port, SM1310/1550 nm, Higher DR      |
| 735035 | √                     | √                       | √                    | —               | —                  | √           | √           | 1-port, SM1310/1490/1550 nm            |
| 735036 | √                     | √                       | —                    | √               | —                  | √           | √           | 2-port, SM1310/1550/1625 nm, filter    |
| 735037 | √                     | √                       | —                    | —               | —                  | √           | √           | 2-port, SM1310/1550/1650 nm, filter    |
| 735038 | √                     | √                       | √                    | √               | —                  | √           | √           | 1-port, SM1310/1550/1625 nm            |
| 735041 | √*1                   | √*1                     | —                    | —               | —                  | √           | —           | 2-ports, MM850/1300 nm, SM1310/1550 nm |

\*1 : MMF is not supported.  
√ : Available.

|                   | Suffix Codes | Description                    |
|-------------------|--------------|--------------------------------|
| Optical Connector | -SCC         | SC type connector              |
|                   | -FCC         | FC type connector              |
|                   | -NON         | No universal adapter           |
|                   | -USC         | Universal adapter (SC)         |
|                   | -UFC         | Universal adapter (FC)         |
|                   | -ASC         | Angled-PC connector (SC) *2    |
| Language          | -HE          | English                        |
|                   | -HC          | Chinese/English                |
|                   | -HK          | Korean/English                 |
|                   | -HR          | Russian/English                |
| Power Cord        | -D           | UL/CSA standard                |
|                   | -F           | VDE standard                   |
|                   | -R           | AS standard                    |
|                   | -Q           | BS/Singapore standard          |
|                   | -H           | GB standard, Complied with CCC |
|                   | -P           | Korean standard                |
| Options           | /PM          | Optical power monitor          |
|                   | /SLS         | Stabilized light source        |
|                   | /VLS         | Visible light source           |
|                   | /PN          | PON measurement                |
|                   | /DR          | High Dynamic range             |
|                   | /PL          | Built-in printer, LAN          |
|                   | /DF          | Dummy fiber (SMF)              |
|                   | /SB          | Shoulder belt                  |

\*2: An angled-PC connector cannot be used in the MM port of the 735040. -USC needs to be attached.

#### Example: 735033-USC-HE-D/PM/SLS

AQ7275 OTDR 1310/1550nm, high dynamic range, with SC universal adapter, English version, with a UL/CSA standard power cord, with optical power monitor function and with stabilized light source function.

#### Standard Accessories

Power cord, AC adapter, battery pack, hand belt, user's manual (CD-ROM), operation guide

## Accessories (Sold Separately)

| Name                            | Model       | Specifications                         |
|---------------------------------|-------------|--|
| Soft carrying case              | 739860      |  |
| Battery pack                    | 739880      |  |
| External large capacity battery | 739881      | With battery case and connection cable |
| Universal adapter (SC)          | SU2005A-SCC | SC type                                |
| Universal adapter (FC)          | SU2005A-FCC | FC type                                |
| Printer roll paper              | A90102P     | 80 mm x 25 m                           |
| Shoulder belt                   | B8070CY     |  |
| AC adapter                      | 739870-D    | UL/CSA standard                        |
|                                 | 739870-F    | VDE standard                           |
|                                 | 739870-R    | AS standard                            |
|                                 | 739870-Q    | BS/Singapore standard                  |
|                                 | 739870-H    | GB standard, Complied with CCC         |
|                                 | 739870-P    | Korean standard                        |



External large capacity battery and case



Attachable to the AQ7275 series OTDR

## Application Software

| Model  | Suffix Codes | Specifications                              |
|--------|--------------|---|
| 735070 |              | AQ7932 Emulation Software (Ver3.0 or later) |
|        | -EN          | English                                     |

# YOKOGAWA

Yokogawa Meters & Instruments Corporation

**YOKOGAWA METERS & INSTRUMENTS CORPORATION**

Global Sales Dept.

Tachihi Bld. No.2, 6-1-3 Sakaecho, Tachikawa-shi, Tokyo, 190-8586 Japan

Phone: +81-42-534-1413 Facsimile: +81-42-534-1426

#### YOKOGAWA CORPORATION OF AMERICA

2 Dart Road, Newnan, GA, 30265-1094 U.S.A.

Phone: +1-770-253-7000 Facsimile: +1-770-254-0928

#### YOKOGAWA EUROPE B. V.

Euroweg 2 3825 HD Amersfoort, THE NETHERLANDS

Phone: +31-88-4641000 Facsimile: +31-88-4641111

#### YOKOGAWA ENGINEERING ASIA PTE. LTD.

5 Bedok South Road, Singapore 469270 SINGAPORE

Phone: +65-6241-9933 Facsimile: +65-6241-2606

#### YOKOGAWA AMERICA DO SUL LTDA.

Praca Acapulco, 31-Santo Amaro, Sao Paulo/SP, BRAZIL CEP-04675-190

Phone: +55-11-5681-2400

Facsimile: +55-11-5681-4434

#### YOKOGAWA MEASURING INSTRUMENTS

#### KOREA CORPORATION

City Air Terminal Bldg., 405-9, #159-6, Samsung-dong,

Kangnam-ku, Seoul, 135-728 KOREA

Phone: +82-2-551-0660 to 0664 Facsimile: +82-2-551-0665

#### YOKOGAWA AUSTRALIA PTY. LTD.

Tower A/112-118 Talavera Road Macquarie Park, NSW 2113

Australia

Phone: +61-2-8870-1100 Facsimile: +61-2-8870-1111

#### YOKOGAWA INDIA LTD.

Plot No. 96, Electronic City Complex, Hosur Road, Bangalore 560100, INDIA

Phone: +91-80-4158-6000 Facsimile: +91-80-2852-1442

#### YOKOGAWA SHANGHAI TRADING CO., LTD.

4F Tower D, Cartelo Crocodile Building, No.568 West Tianshan

Road, Shanghai, CHINA

Phone: +86-21-6239-6363 Facsimile: +86-21-6880-4987

#### YOKOGAWA MIDDLE EAST B. S. C.(C)

P.O.BOX 10070, Manama, Building 577, Road 2516,

Busaiteen 225, Muharraq, SAUDI ARABIA

Phone: +973-17-358100 Facsimile: +973-17-336100

#### YOKOGAWA ELECTRIC CIS LTD.

Grokholskiy per. 13, Build. 2, 4th Floor, 129090, Moscow

RUSSIAN FEDERATION

Phone: +7-495-737-7868 Facsimile: +7-495-737-7869

Represented by :